

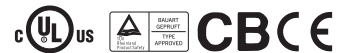

■ Features :

- Universal AC input/Full range
- Protections: Short circuit / Overload / Over voltage
- Cooling by free air convection
- Can be installed on DIN rail TS-35/7.5 or 15
- Built in DC OK active signal
- LED indicator for power on
- No load power consumption<0.75W
- 100% full load burn-in test
- 3 years warranty



**SPECIFICATION**

MODEL	MDR-20-5	MDR-20-12	MDR-20-15	MDR-20-24	
OUTPUT	DC VOLTAGE	5V	12V	15V	24V
	RATED CURRENT	3A	1.67A	1.34A	1A
	CURRENT RANGE	0 ~ 3A	0 ~ 1.67A	0 ~ 1.34A	0 ~ 1A
	RATED POWER	15W	20W	20W	24W
	RIPPLE & NOISE (max.) Note.2	80mVp-p	120mVp-p	120mVp-p	150mVp-p
	VOLTAGE ADJ. RANGE	4.75 ~ 5.5V	10.8 ~ 13.2V	13.5 ~ 16.5V	21.6 ~ 26.4V
	VOLTAGE TOLERANCE Note.3	±2.0%	±1.0%	±1.0%	±1.0%
	LINE REGULATION	±1.0%	±1.0%	±1.0%	±1.0%
	LOAD REGULATION	±1.0%	±1.0%	±1.0%	±1.0%
	SETUP, RISE TIME Note.5	500ms, 30ms/230VAC    1000ms, 30ms/115VAC at full load			
HOLD UP TIME (Typ.)	50ms/230VAC    20ms/115VAC at full load				
INPUT	VOLTAGE RANGE	85 ~ 264VAC    120 ~ 370VDC			
	FREQUENCY RANGE	47 ~ 63Hz			
	EFFICIENCY (Typ.)	76%	80%	81%	84%
	AC CURRENT (Typ.)	0.55A/115VAC    0.35A/230VAC			
	INRUSH CURRENT (Typ.)	COLD START 20A/115VAC    40A/230VAC			
	LEAKAGE CURRENT	<1mA / 240VAC			
PROTECTION	OVERLOAD	105 ~ 160% rated output power Protection type : Constant current limiting, recovers automatically after fault condition is removed			
	OVER VOLTAGE	5.75 ~ 6.75V	13.8 ~ 16.2V	17.25 ~ 20.25V	27.6 ~ 32.4V
		Protection type : Shut down o/p voltage, re-power on to recover			
FUNCTION	DC OK ACTIVE SIGNAL (max.)	3.75 ~ 6V / 50mA	9 ~ 13.5V / 40mA	11.5 ~ 16.5V / 40mA	18 ~ 27V / 20mA
ENVIRONMENT	WORKING TEMP.	-20 ~ +70°C (Refer to "Derating Curve")			
	WORKING HUMIDITY	20 ~ 90% RH non-condensing			
	STORAGE TEMP., HUMIDITY	-40 ~ +85°C, 10 ~ 95% RH			
	TEMP. COEFFICIENT	±0.03%/°C (0 ~ 50°C)			
	VIBRATION	Component:10 ~ 500Hz, 2G 10min./1cycle, 60min. each along X, Y, Z axes; Mounting: Compliance to IEC60068-2-6			
SAFETY & EMC (Note 4)	SAFETY STANDARDS	UL508, TUV EN60950-1 approved			
	WITHSTAND VOLTAGE	I/P-O/P:3KVAC    I/P-FG:2KVAC    O/P-FG:0.5KVAC			
	ISOLATION RESISTANCE	I/P-O/P, I/P-FG, O/P-FG:100M Ohms / 500VDC / 25°C / 70% RH			
	EMC EMISSION	Compliance to EN55011, EN55022 (CISPR22), EN61204-3 Class B, EN61000-3-2,-3			
	EMC IMMUNITY	Compliance to EN61000-4-2, 3, 4, 5, 6, 8, 11, EN55024,EN61000-6-1,EN61204-3, light industry level, criteria A			
OTHERS	MTBF	236.9K hrs min.    MIL-HDBK-217F (25°C)			
	DIMENSION	22.5*90*100mm (W*H*D)			
	PACKING	0.19Kg; 72pcs/14.7Kg/0.91CUFT			
NOTE	<ol style="list-style-type: none"> <li>1. All parameters NOT specially mentioned are measured at 230VAC input, rated load and 25°C of ambient temperature.</li> <li>2. Ripple &amp; noise are measured at 20MHz of bandwidth by using a 12" twisted pair-wire terminated with a 0.1uf &amp; 47uf parallel capacitor.</li> <li>3. Tolerance : includes set up tolerance, line regulation and load regulation.</li> <li>4. The power supply is considered a component which will be installed into a final equipment. The final equipment must be re-confirmed that it still meets EMC directives.</li> <li>5. Length of set up time is measured at cold first start. Turning ON/OFF the power supply may lead to increase of the set up time.</li> </ol>				

■ Mechanical Specification

Case No. 956 Unit:mm

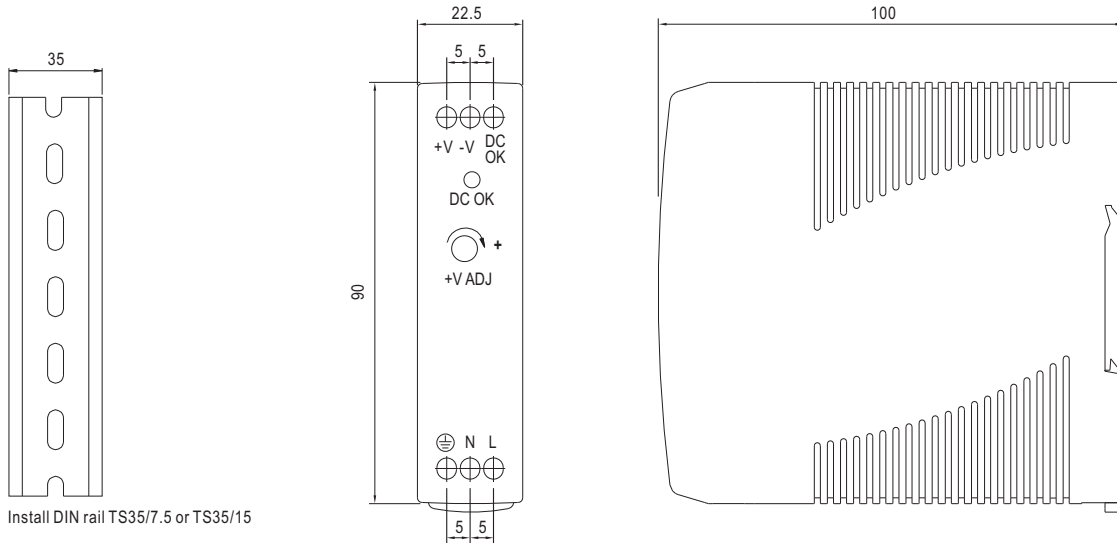

■ Block Diagram

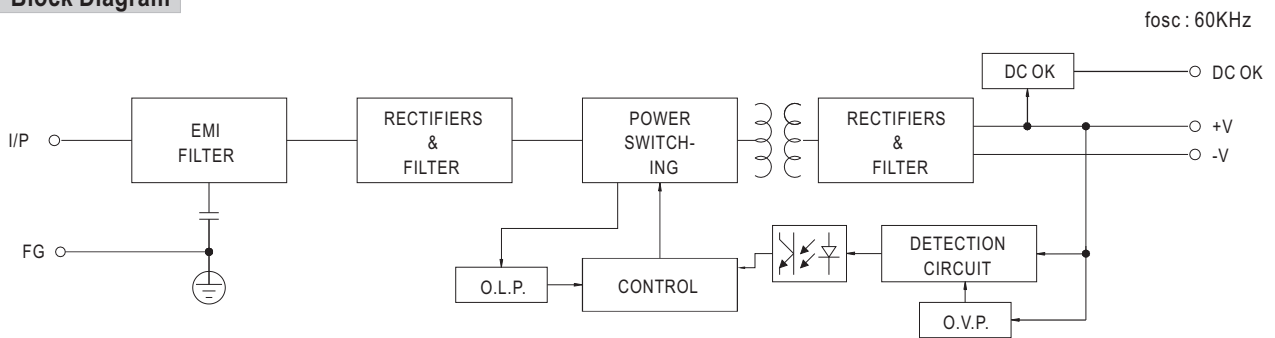

■ Application of DC OK Active Signal

(a) 5V signal

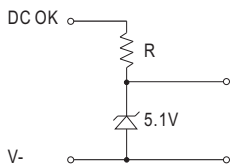

Model	R
5V	$\geq 200\Omega$
12V	$\geq 1.5K\Omega$
15V	$\geq 2K\Omega$
24V	$\geq 3.9K\Omega$

(b) LED

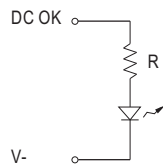

Model	R
5V	$\geq 1K\Omega$
12V	$\geq 2.4K\Omega$
15V	$\geq 3K\Omega$
24V	$\geq 4.7K\Omega$

(c) Relay

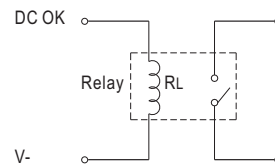

Model	RL
5V	$\geq 120\Omega$
12V	$\geq 700\Omega$
15V	$\geq 700\Omega$
24V	$\geq 1.2K\Omega$

■ Derating Curve

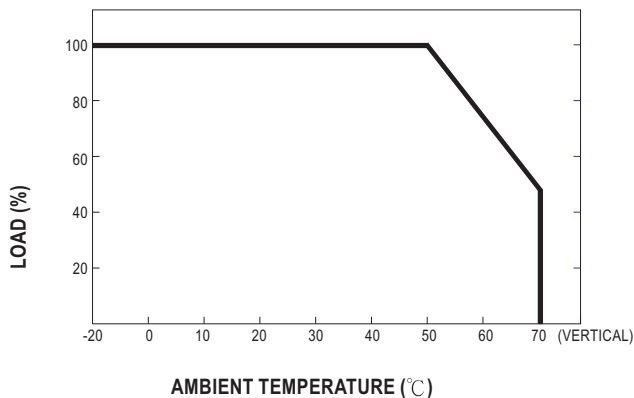

■ Output Derating VS Input Voltage

